

Equipped troughs 42" - U/M

Equipped troughs

Code: 3026 660



DETAILS

Edge/Installation Type	Undermount
Material	AISI 304 stainless steel
Texture	Satin
Finish	Foster brushed
External dimensions	43" x 7"
Internal dimensions	42" x 4 ^{13/16} "
Cut out	42" x 5 ^{7/16} "
Length	7 unit
Standard fittings	Equipped troughs fixing kit (brass insert and screws)

Waste fitting

1¼" drain

Key to understanding the accessories

The lengths of the channels and accessories are indicated in "units"; for the composition, the sum of the "units" of the accessories must be the same as the length in "units" of the channel.

Notes:

The trough includes a stainless-steel bottle-opener that must be used as element to complete the accessories' composition

FEATURES

High thickness 1.2

1.2 mm thick steel. A significant thickness, which guarantees the maximum sturdiness and durability.

TECHNICAL DATA

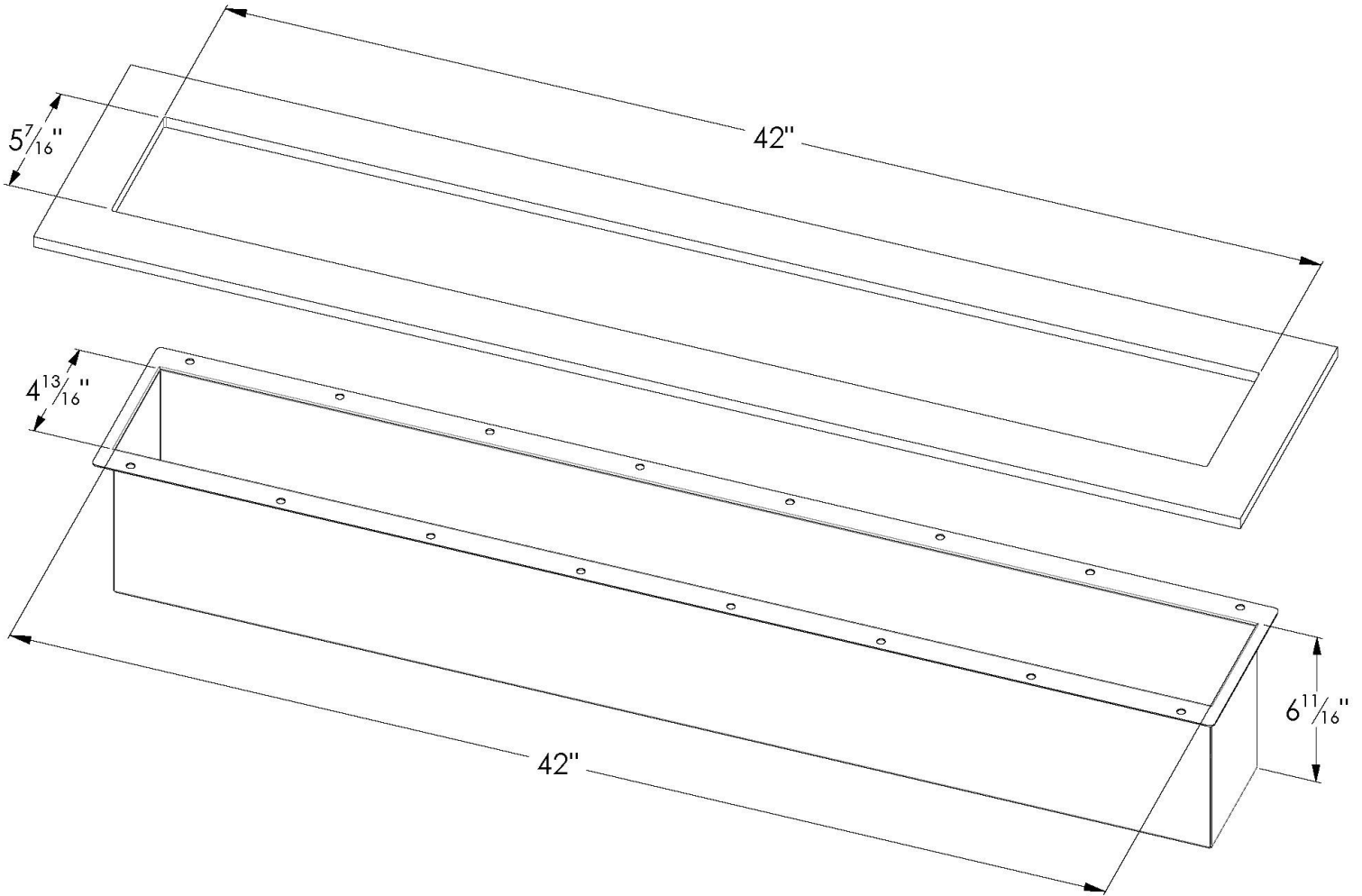

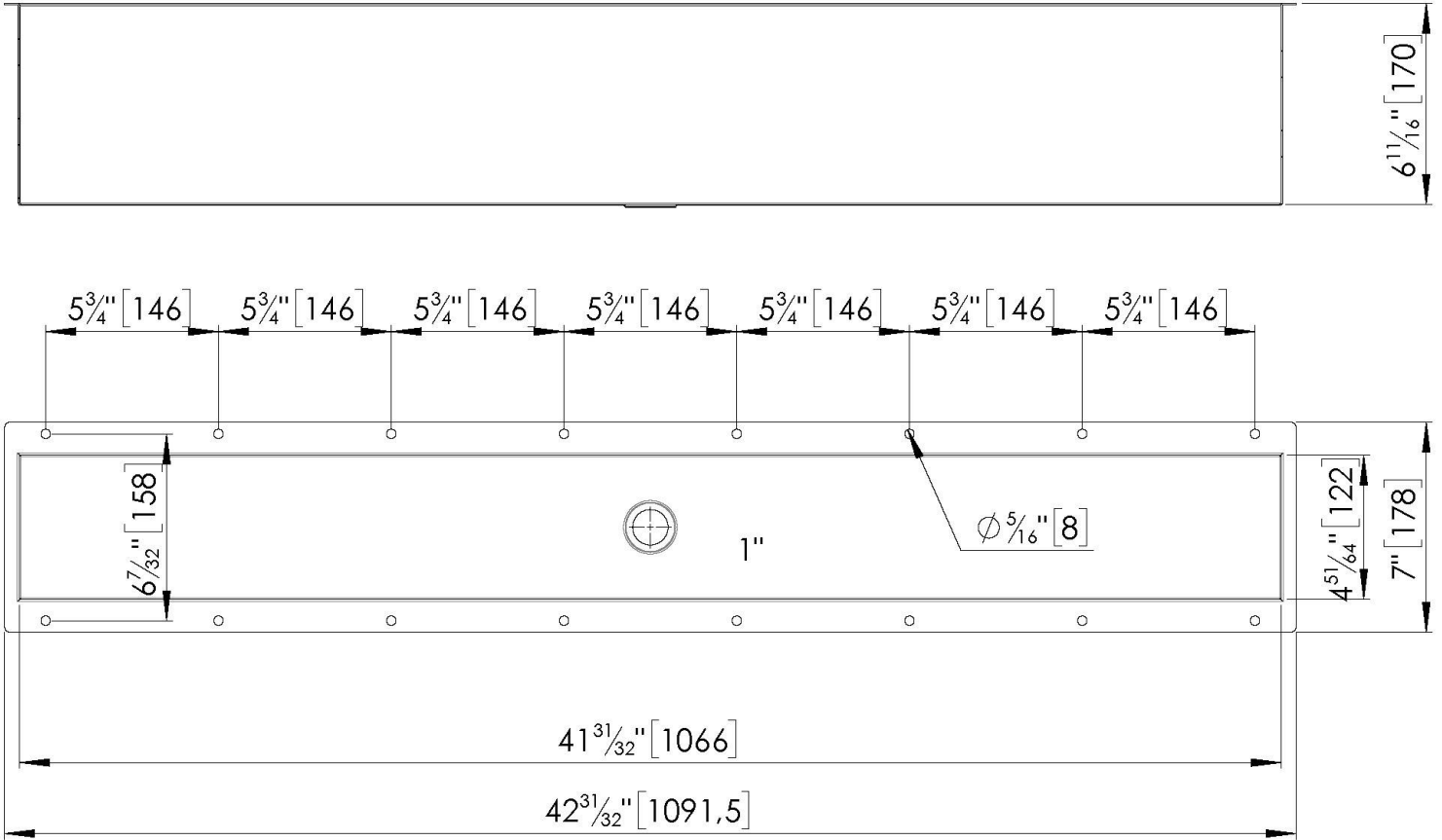

Undermount

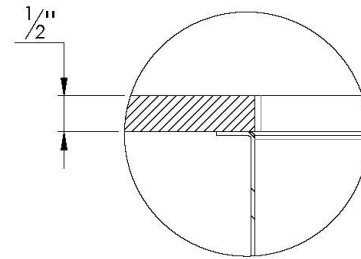
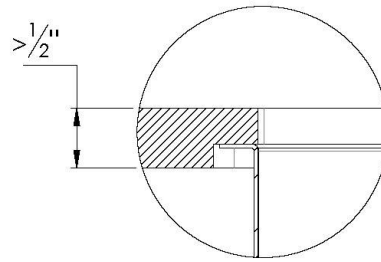

B - B:
Installation detail

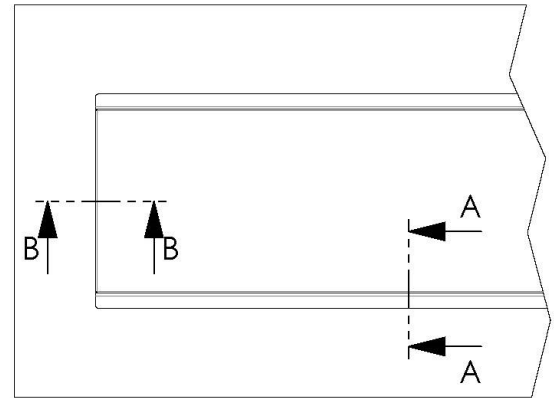
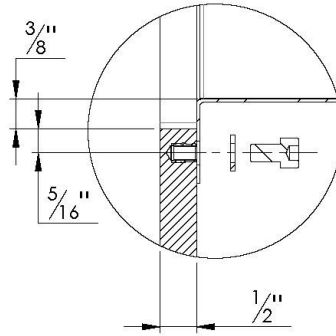
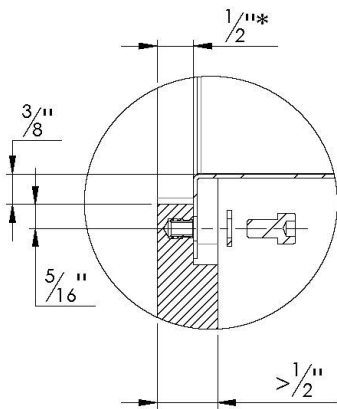

A - A:
Installation detail with positive reveal and fixing system

*reccomended thickness for a perfect match with the accessories

GALLERY



OPTIONAL ACCESSORIES



Kit "A"
8100 703



Kit "B"
8100 700



Kit "C"
8100 701



Kit "D"
8100 704



Kit "E"
8100 705



Kit "F"
8100 706



Kit "G"
8100 710



Kit "H"
8100 702



Black drainer
8100 058



Stainless steel perforated pan
8151 003



Stainless steel knife holder
8100 712

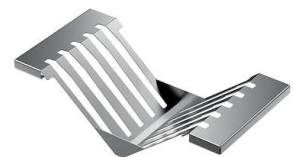

Stainless steel plate rack
1773 100